

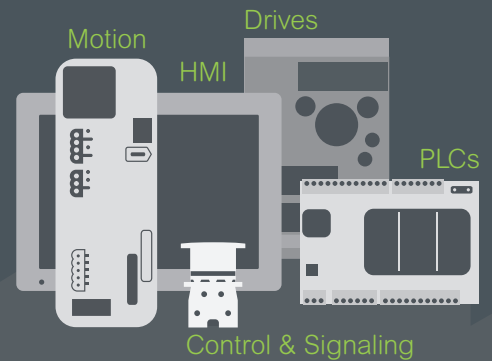

Introducing the **Easy Series**

Essential automation & control products

When just enough is just right!



Easy Altivar 610

Variable speed drives

For applications from 0.75 to 160 kW / 1 to 216 HP



Altivar

Discover Altivar

Variable speed drives and soft starters

Altivar variable speed drives and soft starters deliver top performance in motor control applications across machines, processes, and buildings. With built-in intelligence, these smart connected devices gather and share data to improve operational efficiency, safety, and reliability.

Explore our offer

- [Altivar Process](#)
- [Altivar Machine](#)
- [Altivar Building](#)
- [Altivar Soft Starters](#)

Life Is On

Schneider
Electric

Quick access to product information

Get technical information about your product

References

Modicon TM3
I/O expansion modules for Modicon controllers
Analog I/O modules

Number and type of channels	Input range	Resolution	Aperture time (ms)	Reference	Weight (kg)
2 voltage inputs	-15...+10 VDC 0...20 mA, 4...20 mA	16,000 or 10,000 1/2	0.005	TM3AI2H TM3AI2HG	0.110 0.100
4 voltage inputs	-15...+10 VDC 0...20 mA, 4...20 mA	12,000 or 10,000 1/2	0.005	TM3AI4 TM3AI4G	0.100 0.100
4 voltage or temperature inputs	-15...+10 VDC 0...20 mA, 4...20 mA RTD (PT100, NI1000, NI750, PT200) 0...20 mA, 4...20 mA	16,000 or 10,000 1/2	0.005	TM3AI4T TM3AI4TG	0.110 0.100
4 differential temperature inputs	0...100 °C, 0...200 °C, 0...500 °C 0...100 °C, 0...200 °C, 0...500 °C Non-isolated	16,000 or 10,000 1/2	0.005	TM3IT4 TM3IT4G	0.110 0.100
8 voltage inputs	-15...+10 VDC	12,000 or 10,000 1/2	0.005	TM3I8	0.110

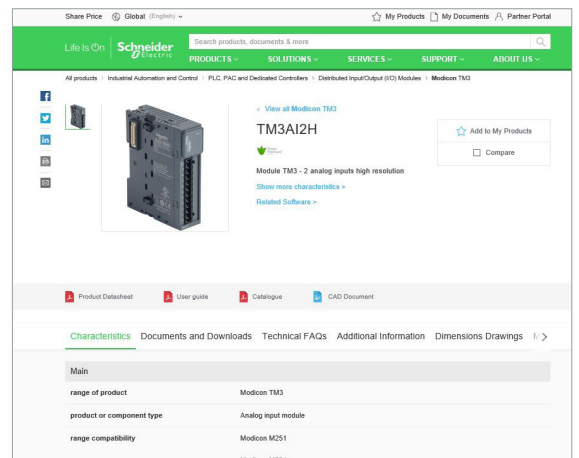

Each commercial reference presented in a catalog contains a hyperlink. Click on it to obtain the technical information of the product:

- Characteristics, Dimensions and drawings, Mounting and clearance, Connections and schemas, Performance curves
- Product image, Instruction sheet, User guide, Product certifications, End of life manual

Find your catalog

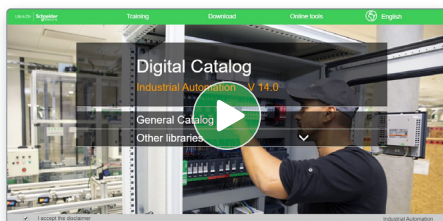

- > With just 3 clicks, you can access the Industrial Automation and Control catalogs, in both English and French
- > Consult digital automation catalogs at [Digi-Cat Online](#)

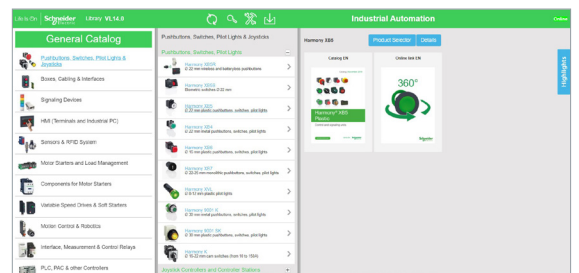

- Up-to-date catalogs
- Embedded product selectors, 360° pictures
- Optimized search by commercial references

Select your training



- > Find the right [Training](#) for your needs on our Global website
- > Locate the training center with the selector tool, using this [link](#)

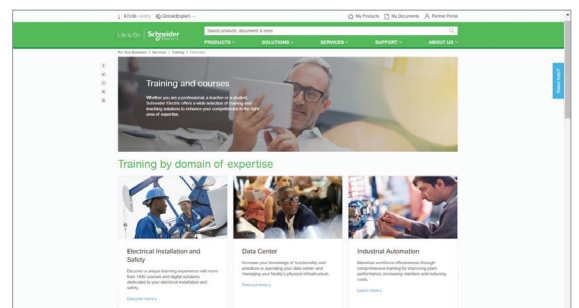

General contents

Easy Altivar 610 variable speed drives

■ Variable speed drives

- Presentation [page 2](#)
- Normal duty and Heavy duty operating modes [page 4](#)
- Integrated parts [page 4](#)
- Configuration and runtime tools [page 5](#)
- Accessories and options [page 5](#)
- References [page 6](#)

■ Configuration and runtime tools

- Plain text display terminal [page 8](#)
- Mounting kit for plain text display terminal [page 9](#)

■ I/O modules, communication and dv/dt filters

- Integrated I/O and I/O option modules [page 11](#)
- Integrated ports and communication protocol [page 11](#)
- Options: dv/dt filters [page 13](#)

■ Motor starters [page 14](#)

■ Coordination table between drives and fuses [page 15](#)

■ Dimensions [page 16](#)

■ Product reference index [page 18](#)



Water & wastewater



Oil & gas



Circulating pumps for building management

Introduction to the offer: applications

The Altivar™ Easy 610 drive is an IP 20 frequency inverter for three-phase asynchronous motors, specially designed for standard applications in the following market segments and domains:

Market segments



Water & wastewater



Oil & gas

Domains



Process & machine management



Building management

Typical applications in the market segments

Water & wastewater

- Intake pump
- Booster pump
- Lifting pump
- Aeration blower

Oil & Gas

- Circulating pump
- Drain pump
- Oil transfer pump

Pump and fan applications in the domains

Process & machine management

- Air cooling system fan
- Circulating pump
- Cooling fan
- Draught fan
- Compressor
- Conveyor

Building management

- Fan
- Circulating pump



ATV610U07N4...ATV610U75N4
ATV610D11N4...ATV610D15N4



ATV610D18N4...ATV610D22N4
ATV610D30N4...ATV610D45N4



ATV610D55N4...ATV610D90N4
ATV610C11N4...ATV610C16N4
ATV610C11N4...ATV610C16N4



Presentation of the offer

The Easy Altivar 610 offer covers motor power ratings from 0.75 to 160 kW/1.04 to 222 HP for three-phase voltages between 380 and 460 V.

Easy Altivar 610 drives can help improve equipment performance and reduce operating costs by optimizing energy consumption and user comfort.

A communication module is available for seamless integration into the main automation architectures.

Easy Altivar 610 drives feature various configurable I/O as standard to facilitate adaptation to specific applications.

They offer a plug & play solution, whereby parameters are preset in the factory to the desired configuration, to help save process control and operating time.

Rugged

Easy Altivar 610 drives are robust products designed to adapt to various levels of thermal stress and to harsh environments.

- Operating temperature (for continuous monitoring)
 - Mounting in enclosure: mounted singly or side-by-side: -15...+60 °C/+5...+140 °F, 45...60 °C/113...140 °F with derating
- Storage and transport temperature: -40...+70 °C /-104...+158 °F
- Operating altitude:
 - 0...1,000 m without derating
 - 1,000...4,800 m with derating of 1% per 100 m/328.08 ft
 - chemical class 3C3 conforming to IEC/EN 60721
 - mechanical class 3S3 conforming to IEC/EN 60721
 - electronic cards with protective coating
- Protection to suit requirements:
 - IP 20 for mounting in enclosure
 - IP 40 on the top of the product (with top cover)
 - IP 43 for remote display terminal

Electromagnetic compatibility (EMC)

Compliance with electromagnetic compatibility requirements has been incorporated into the design of the drive, which simplifies installation and provides an economical means of helping to ensure equipment meets CE marking requirements.

Easy Altivar 610 drives have a category C3 EMC filter (see [page 4](#)).

Installation and maintenance

Easy Altivar 610 drives are ergonomically designed to adapt to any type of installation:

- Products, systems, or integrated in IMCC
- IP 20
- Easy installation of products and systems:
 - cable entry equipped with Romex cable glands to maintain an EMC connection for the power and control cable
 - color code for connections to the display terminal and control terminals
- Asynchronous drive in open loop for 0.1...500 Hz output frequency
- Lower maintenance costs:
 - fans can be replaced in less than 5 minutes
 - no maintenance tool required
 - limited number of parts

Green product

Easy Altivar 610 drives have been designed to have a smaller carbon footprint: the Green Premium product label, Schneider Electric's eco-mark, indicates your compliance with international environmental standards such as:

- RoHS-2 according to EU directive CE 2002/95
- REACH according to EU regulation 1907/2006
- IEC 62635: the end-of-life instructions comply with the latest recycling rules, 70% of the product components can be recycled.

Normal duty and Heavy duty operating modes

The Easy Altivar 610 offer covers motor power ratings from 0.75...160 kW/1...216 HP for three-phase voltages between 380 and 460 V.

Three-phase power supply	Motor power	Degree of protection	Reference
380...460 V	0.75 kW...160 kW 1...216 HP	IP 20	ATV610U07N4... C16N4

Easy Altivar 610 variable speed drives are designed for use in two operating modes that can optimize the drive nominal rating according to the system constraints.

These two modes are:

- Normal duty (ND): Dedicated mode for applications requiring a slight overload (up to 110% for 60 s or 120% for 20 s) with a motor power no higher than the drive nominal power
- Heavy duty (HD): Dedicated mode for applications requiring a significant overload (up to 150% for 60 s) with a motor power no higher than the drive nominal power derated by one rating

These 2 operating modes make the Easy Altivar 610 range suitable for use in variable and constant torque applications, such as pump, fan, compressor, and conveyor.

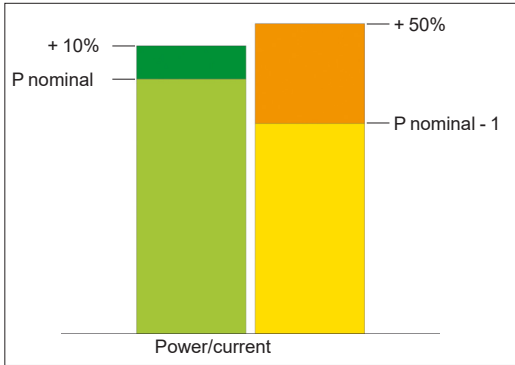

Normal duty and Heavy duty modes

Integration

Integrated DC chokes

Above 4 kW/5 HP, Easy Altivar 610 variable speed drives are supplied with an integrated DC choke to reduce harmonic distortion.

Integrated EMC filters

Easy Altivar 610 drives have integrated radio interference input filters in accordance with the EMC standard for variable speed electrical power drive "products" IEC/EN 61800-3, edition 2, category C3 in environment 1 or 2, and to comply with the European EMC (electromagnetic compatibility) directive.

Maximum length of shielded cable (1) according to IEC/EN 61800-3, category C3: 50 m/164.04 ft (for all ratings).

The integrated EMC filter creates leakage current to ground. It is possible to reduce the leakage current by removing the capacitors of the filters (see the diagrams on our website or refer to the Installation Manual). In this configuration, the product does not meet the EMC requirements according to standard IEC 61800-3.

Communication protocol

The Modbus serial link allows the connection of configuration and runtime tools via 2 integrated ports.

(1) Values given depend on the nominal switching frequency of the drive. This frequency depends on the drive rating. If motors are connected in parallel, it is the total length of all cables that should be taken into account.

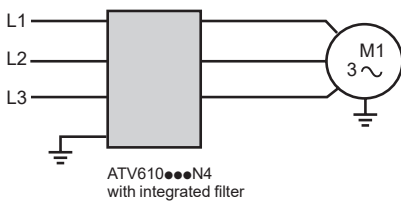

Easy Altivar 610 drive with integrated EMC filter

Configuration and runtime tools

Easy Altivar 610 drives are supplied with a plain text display terminal (see [page 8](#)), offering the following functions:

- drive control, adjustment, and configuration
- display of current values (motor, I/O, etc.)
- configuration storage and download
- duplication of one drive configuration on another drive
- remote use by means of appropriate accessories (see [page 9](#))
- read/write values

Accessories and options

Accessories

Easy Altivar 610 drives are designed to take complementary accessories to increase their functionality.

- Drive:
 - plate for EMC mounting (see [page 7](#))
- Plain text display terminal:
 - kit for mounting on enclosure door (see [page 9](#))

Options

Easy Altivar 610 integrates a certain number of I/O as standard (see [page 11](#)).

The following options can be added:

- Modules:
 - I/O option modules (see [page 11](#)):
 - 2 analog inputs
 - 6 digital inputs
 - 2 digital outputs
 - relay output module (see [page 11](#)):
 - 3 NO contacts
 - communication module (see [page 12](#)):
 - Profibus DP V1 bus
- Output filters:
 - dv/dt filters (see [page 13](#))

Motor starters

Schneider Electric offers combinations of circuit breakers and contactors to be able to use Easy Altivar 610 drives in optimum conditions (see [page 14](#)).

Variable speed drives

Easy Altivar 610

Supply voltage 380...460 V 50/60Hz



ATV610U07N4



ATV610D18N4



ATV610C11N4

IP 20 three-phase 380...460 V drives with integrated category C3 EMC filter										
Motor			Power part supply				Easy Altivar 610			
Nominal power indicated on rating plate (1)			Max. input current (2)		Apparent power	Max. prospective line Isc	Maximum continuous current (1)	Maximum transient current for 60 s	Reference	Weight
	kW	HP	380 V	460 V	460 V					
ND: Normal duty (3)										
HD: Heavy duty (4)										
	kW	HP	A	A	kVA	kA	A	A		kg/lb
ND	0.75	1	3.1	2.6	2.1	5	2.2	2.4	ATV610U07N4	2.400/5.291
HD	0.37	0.5	1.7	1.4	1.1	5	1.5	2.3		
ND	1.5	2	5.7	4.8	3.8	5	4.0	4.4	ATV610U15N4	2.400/5.291
HD	0.75	1	3.1	2.6	2.1	5	2.2	3.3		
ND	2.2	3	7.8	6.5	5.2	5	5.6	6.2	ATV610U22N4	2.400/5.291
HD	1.5	2	5.6	4.6	3.7	5	4.0	6.0		
ND	3	4	10.1	8.4	6.7	5	7.2	7.9	ATV610U30N4	2.400/5.291
HD	2.2	3	7.6	6.4	5.1	5	5.6	8.4		
ND	4	5	8.8	7.9	6.3	5	9.3	10.2	ATV610U40N4	4.000/8.818
HD	3	-	7.2	6.2	4.9	5	7.2	10.8		
ND	5.5	7.5	11.6	10.5	8.4	22	12.7	14.0	ATV610U55N4	4.100/9.039
HD	4	5	8.9	7.9	6.3	22	9.3	14.0		
ND	7.5	10	14.7	12.8	10.2	22	15.8	17.4	ATV610U75N4	4.100/9.039
HD	5.5	7.5	11.3	10.2	8.1	22	12.7	19.1		
ND	11	15	22.0	19.6	15.6	22	23.5	25.9	ATV610D11N4	7.200/15.873
HD	7.5	10	16.4	14.6	11.6	22	16.5	24.8		
ND	15	20	29.4	26.0	20.7	22	31.7	34.9	ATV610D15N4	7.200/15.873
HD	11	15	23.0	20.8	16.6	22	23.5	35.3		
ND	18.5	25	37.2	33.5	26.7	22	39.2	43.1	ATV610D18N4	13.300/29.321
HD	15	20	31.6	28.3	22.6	22	31.7	47.6		
ND	22	30	41.9	36.2	28.8	22	46.3	50.9	ATV610D22N4	13.900/30.644
HD	18.5	25	36.0	31.6	25.2	22	39.2	58.8		
ND	30	40	62.5	55.8	44.5	22	61.5	67.7	ATV610D30N4	26.100/57.541
HD	22	30	49.7	42.5	33.8	22	46.3	69.5		
ND	37	50	76.6	68.3	54.4	22	74.5	82.0	ATV610D37N4	26.800/59.084
HD	30	40	65.8	56.8	45.2	22	59.6	89.4		
ND	45	60	92.9	82.7	65.9	22	88	97	ATV610D45N4	26.800/59.084
HD	37	50	80.5	69.6	55.4	22	74.5	112		
ND	55	75	111.5	99.7	79.5	22	120	132	ATV610D55N4	53.700/118.388
HD	45	60	95.9	84.0	66.9	22	88	132		
ND	75	100	147.9	130.2	103.7	22	145	160	ATV610D75N4	53.700/118.388
HD	55	75	115.8	101.7	81.0	22	106	159		
ND	90	125	177.8	159.9	127.4	50	173	190	ATV610D90N4	53.700/118.388
HD	75	100	155.8	138.1	110.0	50	145	218		
ND	110	149	201.0	175.7	140.0	50	211	232	ATV610C11N4	82.000/180.779
HD	90	125	170.0	149.1	118.8	50	173	260		
ND	132	178	237.0	203.8	162.4	50	250	275	ATV610C13N4	82.000/180.779
HD	110	149	201.0	174.2	138.7	50	211	317		
ND	160	216	284.0	249.5	198.8	50	302	332	ATV610C16N4	82.000/180.779
HD	132	178	237.0	205.9	164.0	50	250	375		

(1) These values are given for a nominal switching frequency of 4 kHz up to **ATV610D45N4**, or 2.5 kHz for **ATV610D55N4...C16N4** for use in continuous operation.

The switching frequency is adjustable from 2...12 kHz up to **ATV610D45N4**, or from 1...8 kHz for **ATV610D55N4...C16N4**. Above 2.5 or 4 kHz (depending on the rating), the drive will automatically reduce the switching frequency in the event of an excessive temperature rise. For continuous operation above the nominal switching frequency, derate the nominal drive current (see the derating curves on our website).

(2) Typical value for the indicated motor power and for the maximum prospective line Isc.

(3) Values given for applications requiring a slight overload (up to 110 % for 60 s or 120% for 20 s).

(4) Values given for applications requiring a slight overload (up to 150 % for 60 s).

Variable speed drives

Easy Altivar 610

Supply voltage 380...460 V 50/60Hz



ATV610U07N4Z



ATV610D11N4Z

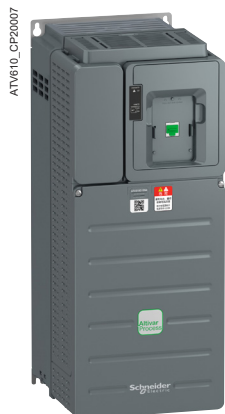

ATV610D18N4Z

IP 20 three-phase 380...460 V drives with integrated category C3 EMC filter										
Motor		Power part supply					Easy Altivar 610			
Nominal power indicated on rating plate (1)	kW	HP	Max. input current (2)		Apparent power	Max. prospective line Isc	Maximum continuous current (1)	Maximum transient current for 60 s	Reference	Weight
			380 V	460 V						
ND: Normal duty (3)										
HD: Heavy duty (4)										
	kW	HP	A	A	kVA	kA	A	A		kg/lb
ND	0.75	1	3.1	2.6	2.1	5	2.2	2.4	ATV610U07N4Z	2.240/4.938
HD	0.37	0.5	1.7	1.4	1.1	5	1.5	2.3		
ND	1.5	2	5.7	4.8	3.8	5	4.0	4.4	ATV610U15N4Z	2.240/4.938
HD	0.75	1	3.1	2.6	2.1	5	2.2	3.3		
ND	2.2	3	7.8	6.5	5.2	5	5.6	6.2	ATV610U22N4Z	2.240/4.938
HD	1.5	2	5.6	4.6	3.7	5	4.0	6.0		
ND	3	4	10.1	8.4	6.7	5	7.2	7.9	ATV610U30N4Z	2.240/4.938
HD	2.2	3	7.6	6.4	5.1	5	5.6	8.4		
ND	4	5	8.8	7.9	6.3	5	9.3	10.2	ATV610U40N4Z	3.840/8.465
HD	3	-	7.2	6.2	4.9	5	7.2	10.8		
ND	5.5	7.5	11.6	10.5	8.4	22	12.7	14.0	ATV610U55N4Z	3.940/8.686
HD	4	5	8.9	7.9	6.3	22	9.3	14.0		
ND	7.5	10	14.7	12.8	10.2	22	15.8	17.4	ATV610U75N4Z	3.940/8.686
HD	5.5	7.5	11.3	10.2	8.1	22	12.7	19.1		
ND	11	15	22.0	19.6	15.6	22	23.5	25.9	ATV610D11N4Z	7.010/15.454
HD	7.5	10	16.4	14.6	11.6	22	16.5	24.8		
ND	15	20	29.4	26.0	20.7	22	31.7	34.9	ATV610D15N4Z	7.010/15.454
HD	11	15	23.0	20.8	16.6	22	23.5	35.3		
ND	18.5	25	37.2	33.5	26.7	22	39.2	43.1	ATV610D18N4Z	12.990/28.638
HD	15	20	31.6	28.3	22.6	22	31.7	47.6		
ND	22	30	41.9	36.2	28.8	22	46.3	50.9	ATV610D22N4Z	12.990/28.638
HD	18.5	25	36.0	31.6	25.2	22	39.2	58.8		
ND	30	40	62.5	55.8	44.5	22	61.5	67.7	ATV610D30N4Z	35.590/78.462
HD	22	30	49.7	42.5	33.8	22	46.3	69.5		
ND	37	50	76.6	68.3	54.4	22	74.5	82.0	ATV610D37N4Z	35.590/78.462
HD	30	40	65.8	56.8	45.2	22	59.6	89.4		
ND	45	60	92.9	82.7	65.9	22	88	97	ATV610D45N4Z	35.590/78.462
HD	37	50	80.5	69.6	55.4	22	74.5	112		
ND	55	75	111.5	99.7	79.5	22	120	132	ATV610D55N4Z	51.26/113.008
HD	45	60	95.9	84.0	66.9	22	88	132		
ND	75	100	147.9	130.2	103.7	22	145	160	ATV610D75N4	51.26/113.008
HD	55	75	115.8	101.7	81.0	22	106	159		
ND	90	125	177.8	159.9	127.4	50	173	190	ATV610D90N4Z	51.26/113.008
HD	75	100	155.8	138.1	110.0	50	145	218		
ND	110	149	201.0	175.7	140.0	50	211	232	ATV610C11N4Z	79.94/176.237
HD	90	125	170.0	149.1	118.8	50	173	260		
ND	132	178	237.0	203.8	162.4	50	250	275	ATV610C13N4Z	79.94/176.237
HD	110	149	201.0	174.2	138.7	50	211	317		
ND	160	216	284.0	249.5	198.8	50	302	332	ATV610C16N4Z	79.94/176.237
HD	132	178	237.0	205.9	164.0	50	250	375		

(1) These values are given for a nominal switching frequency of 4 kHz up to **ATV610D45N4Z**, or 2.5 kHz for **ATV610D55N4Z...C16N4Z** for use in continuous operation.
The switching frequency is adjustable from 2...12 kHz up to **ATV610D45N4Z**, or from 1...8 kHz for **ATV610D55N4Z...C16N4Z**. Above 2.5 or 4 kHz (depending on the rating), the drive will automatically reduce the switching frequency in the event of an excessive temperature rise. For continuous operation above the nominal switching frequency, derate the nominal drive current (see the derating curves on our website).

(2) Typical value for the indicated motor power and for the maximum prospective line Isc.

(3) Values given for applications requiring a slight overload (up to 110 % for 60 s or 120% for 20 s).

(4) Values given for applications requiring a slight overload (up to 150 % for 60 s).



VW3A9704

Accessories for mounting of variable speed drives

Kit for IP 21 conformity

For use with variable speed drives	Power		Reference
	kW	HP	
ATV610C11N4●...C16N4● (5)	110...160	149...216	VW3A9704

(5) ATV610C11N4Z...C16N4Z used this kit, IP level is IP20.



Plain text display terminal

Plain text display terminal

The plain text display terminal is supplied with the drive. It can also be ordered as a spare part.

This terminal can be:

- Connected and mounted on the front of the drive
- Connected and mounted on an enclosure door using a remote mounting accessory

This terminal is used to:

- Control, adjust, and configure the drive
- Display current values (motor, I/O, and process data)
- Store and download configurations (several configuration files can be stored in the memory)
- Duplicate the configuration of one powered-up drive on another powered-up drive

Other features:

- 2 lines
- Languages (Chinese, English, French, German, Italian, Spanish)
- White backlight
- Operating range: -15...50 °C/+5...122 °F
- IP 21 protection
- Removable, easy access with RJ45 port

Description

The front of the display terminal comprises:

- 1 LCD backlight screen
- 2 "OK" button: saves the current value (ENT)
- 3 "RUN" button: local control of motor run command
- 4 "STOP/RESET" button: local control of motor stop command/clearing detected faults
- 5 "ESC" button: aborts a value, parameter, or menu to return to the previous selection
- 6 Home: root menu
- 7 Turn ±: increases or decreases the value, goes to the next or previous line

References

Description	Reference	Weight kg/ lb
Plain text display terminal	VW3A1113	0.200/ 0.441

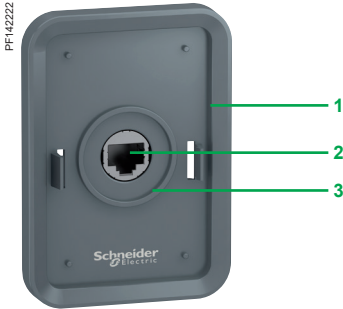

Remote mounting kit for mounting plain text display terminal on enclosure door (front panel)

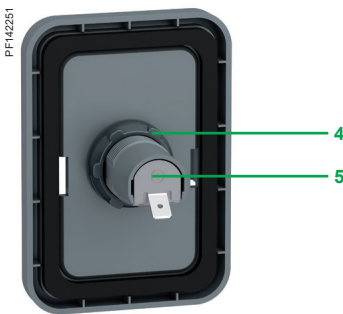

Remote mounting kit for mounting plain text display terminal on enclosure door (rear panel)

Mounting kit for plain text display terminal

■ Remote mounting kit for mounting on an enclosure door with IP 43 degree of protection as standard

Description

The kit comprises:

- Tightening tool (also sold separately under the reference ZB5AZ905)

- 1 Mounting plate
- 2 RJ45 port for the plain text display terminal
- 3 Seal
- 4 Fixing nut
- 5 RJ45 port for connecting the remote-mounting cordset

Cordsets must be ordered separately depending on the length required. Drilling a hole with a standard $\varnothing 22$ tool, as used for a pushbutton, allows the unit to be mounted without needing a cut-out in the enclosure ($\varnothing 22.5$ mm/ $\varnothing 0.89$ in. drill hole).

An anti-rotation function is provided and operates as follows: when the kit is locked on the panel tightly by the nut, the gasket on the back cannot rotate.

References

Description	Length m/ ft	IP degree of protection	Reference	Weight kg/ lb
Remote mounting kit Order with remote-mounting cordset VW3A1104R●●●	–	43	VW3A1114	–
Tightening tool for remote mounting kit	–	–	ZB5AZ905	0.016/ 0.035
Remote-mounting cordset equipped with 2 RJ45 connectors	1/ 3.28	–	VW3A1104R10	0.050/ 0.110
	3/ 9.84	–	VW3A1104R30	0.150/ 0.331
	5/ 16.40	–	VW3A1104R50	0.250/ 0.551
	10/ 32.81	–	VW3A1104R100	0.500/ 1.102

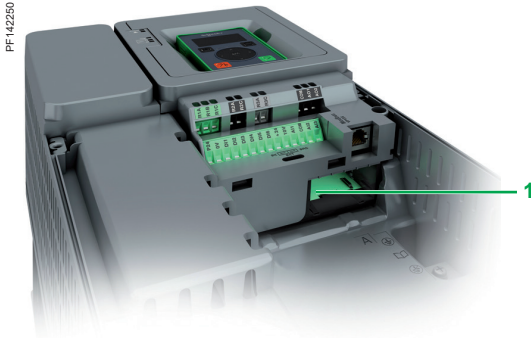

VW3A3203

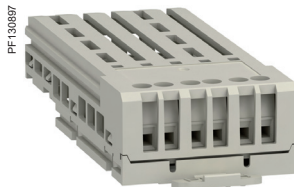

VW3A3204

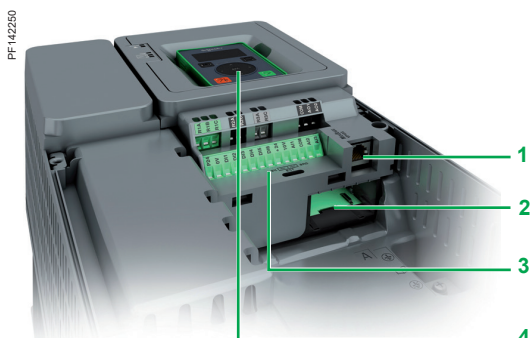

Integrated I/O and I/O option modules

Presentation

Easy Altivar 610 integrates the following types of I/O as standard:

- 3 analog inputs 0...10 V/0...20 mA (software-configurable voltage or current, temperature probe, and water level sensor)
- 6 digital inputs 24 V DC (2 of which can be programmed as pulse inputs)
- 2 analog outputs 0...10 V/0...20 mA (software-configurable voltage or current)
- 3 relay outputs (configurable relay logic)

By installing I/O option modules, Easy Altivar 610 drives can be adapted to meet the needs of applications that manage additional sensors or specific sensors.

2 I/O option modules are available:

- Digital and analog I/O option module
- Relay output module

These I/O modules as well as the communication modules insert into slot A on Easy Altivar 610 drives **1**.

Digital and analog I/O option module

- 2 differential analog inputs configurable via software as current (0-20 mA/4-20 mA) or probe (PTC, PT100, or 2-wire or 3-wire PT1000) inputs
 - 14-bit resolution
- 6 x 24 V $\overline{\text{DC}}$ positive or negative digital inputs
- sampling: 1 ms max.
- 2 assignable digital outputs

Relay output module

- 3 relay outputs with NO contacts
- 1 fixed screw terminal block

References

Description	I/O type				Reference	Weight kg/ lb
	Digital inputs	Digital outputs	Analog inputs	Relay outputs		
Digital and analog I/O module	6	2	2 (1)	–	VW3A3203	–
Relay output module	–	–	–	3 (2)	VW3A3204	–

Integrated ports and communication protocol

Presentation

Easy Altivar 610 drives have 2 built-in RJ45 communication ports as standard:

- one port dedicated to field network operation for exchanging data with other devices via the Modbus serial link protocol **1**
- a second dedicated port for the multidrop connection of the following HMIs and configuration tools **4**:
 - the plain text terminal
 - a Magelis industrial HMI terminal

Easy Altivar 610 drives integrate the Modbus serial link communication protocol as standard. The detailed specifications for serial communication ports and the Modbus protocol are available on our local website.

Description

- 1 RJ45 serial port
- 2 Slot A for I/O expansion or communication modules
- 3 Fixed screw terminal blocks for 24 V $\overline{\text{DC}}$ power supply and integrated I/O
- 4 RJ45 serial link for HMI (remote plain text terminal, Magelis terminal, etc.)

Easy Altivar 610 drives can take one communication module, or digital and analog I/O option module, or relay output module in slot A.

Note: The user manuals and description files (gsd) for devices on the communication buses and networks are available on our website.

(1) Differential analog inputs configurable via software as current (0-20 mA/4-20 mA) or probe (PTC, PT100, or 2-wire or 3-wire PT1000) inputs. When configured as PTC probe inputs, they must never be used to protect an ATEX motor in applications in explosive atmospheres. Please refer to the ATEX guide on our website.

(2) NO contacts.

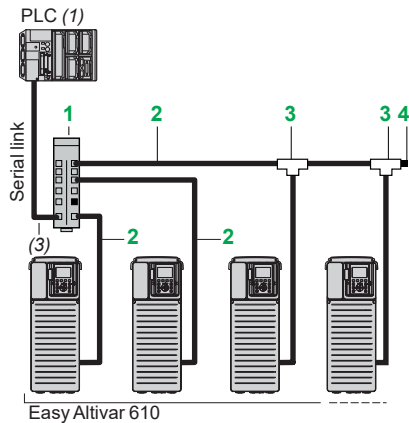

Example of serial link architecture

Integrated serial port (continued)

Description	Item	Length m/ ft	Unit reference	Weight kg/ lb
Connection accessories				
Splitter box 10 RJ45 connectors and 1 screw terminal block	1	–	LU9GC3	0.500/ 1.102
Modbus T-junction boxes With 0.3 m/0.98 ft integrated cable	3	0.3/ 0.98	VW3A8306TF03	0.190/ 0.419
With 1 m/3.28 ft integrated cable	3	1/ 3.28	VW3A8306TF10	0.210/ 0.463
Modbus line terminator (2) For RJ45 connector	4	R = 120 Ω C = 1 nf	VW3A8306RC	0.010/ 0.022
Cordsets equipped with 2 RJ45 connectors	2	0.3/ 0.98	VW3A8306R03	0.025/ 0.055
		1/ 3.28	VW3A8306R10	0.060/ 0.132
		3/ 9.84	VW3A8306R30	0.130/ 0.287

PROFIBUS DP V1 optional communication module

Presentation and functions

Easy Altivar 610 drives can also be connected to other industrial communication buses and networks using the communication module available as an option. This communication module is supplied in "cassette" format for ease of mounting/removal.

Dedicated communication module: PROFIBUS DP V1.

PROFIBUS DP V1 module also supports the Profidrive and CiA402 profiles.

It is possible to maintain communication using a separate power supply for the control and power sections. Monitoring and diagnostics are possible via the network even if there is no power supply to the power section.

All drive functions can be accessed via the various communication networks:

- Configuration
- Adjustment
- Control
- Monitoring

Easy Altivar 610 drives offer a high degree of interfacing flexibility with the possibility to assign, by configuration, the different control sources (I/O, communication networks, and HMI terminal) to control functions in order to meet the requirements of complex applications.

Communication is monitored according to the specific criteria for each protocol.

However, regardless of the protocol, it is possible to configure how the drive responds to a detected communication interruption, as follows:

- Define the type of stop when a communication interruption is detected
- Maintain last command received
- Ignore the detected communication interruption

References

Description	Reference	Weight kg/ lb
PROFIBUS DP V1 communication module Port: 1 x 9-way female SUB-D connector Conforming to PROFIBUS DP V1 Profiles supported: ■ CiA 402 drive ■ Profidrive Offers several message handling modes based on DP V1	VW3A3607	0.140/ 0.309
IP 20 straight connectors (4) for Profibus module (SUB-D connection)	LU9AD7	–

(1) Please refer to the PLC catalogs on our website.

(2) Order in multiples of 2.

(3) Cable depends on the PLC.

(4) Only straight connectors are compatible with Easy Altivar 610 drives.



VW3A3607

Presentation

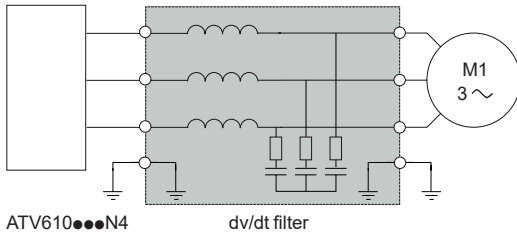

ATV610...N4

dv/dt filter

Easy Altivar 610 drive with dv/dt filter

Easy Altivar 610 drives operate with the following maximum motor cable lengths (without dv/dt filters):

- ATV610U07N4...U55N4:
 - 100 m/328.08 ft for shielded cables
 - 150 m/492.13 ft for unshielded cables

- ATV610U75N4...D45N4:
 - 100 m/328.08 ft for shielded cables
 - 200 m/656.17 ft for unshielded cables

- ATV610D55N4...D90N4:
 - 150 m/492.13 ft for shielded cables
 - 200 m/656.17 ft for unshielded cables

- ATV610C11N4...C16N4:
 - 150 m/492.13 ft for shielded cables
 - 200 m/656.17 ft for unshielded cables

To limit the impact of dv/dt filters and overvoltages at the motor side, it is recommended, for cables longer than 50 m/164 ft, that you check the motor insulation type and add an output filter if necessary.

Output filters are used to limit dv/dt at the motor terminals.

They are also used to:

- Limit overvoltages at the motor terminals to:
 - 1000 V at 400 V ~ (rms value)
- Filter interference caused by opening a contactor placed between the filter and the motor
- Reduce the motor ground leakage current

The performance of dv/dt filters will be affected if the maximum cable lengths are exceeded. For an application with several motors connected in parallel, the cable length must include all cabling. If a cable longer than that recommended is used, the dv/dt filters may overheat.

dv/dt filters

For drives	Maximum length of motor cable			Degree of protection	Nominal current	Unit reference	Weight
	Maximum switching frequency (1)	Shielded cable (2)	Unshielded cable (2)				
	kHz	m/ft	m/ft	IP	A		kg/lb
Three-phase supply voltage: 380...460 V							
ATV610U07N4...U22N4	4	150/492.13	200/656.17	20	6	VW3A5301	11.000/ 24.251
ATV610U30N4...U55N4	4	150/492.13	200/656.17	20	15	VW3A5302	12.000/ 26.455
ATV610U75N4...D15N4	4	250/820.21	300/984.25	20	25	VW3A5303	12.000/ 26.455
ATV610D18N4...D22N4	4	250/820.21	300/984.25	20	50	VW3A5304	18.000/ 39.683
ATV610D30N4...D45N4	4	250/820.21	300/984.25	20	95	VW3A5305	19.000/ 41.888
ATV610D55N4...D90N4	2.5	300/984.25	350/1148.29	00	180	VW3A5306	22.000/ 48.502
ATV610C11N4...C16N4	2.5	300/984.25	350/1148.29	00	305	VW3A5307	40.000/ 88.185

(1) The filters are designed to operate in a switching frequency range of between 2 and 8 kHz.

(2) Values given depend on the nominal switching frequency of the drive. This frequency depends on the drive rating. These cable lengths are given as examples only as they can vary depending on the application. They correspond to motors conforming to IEC 6034-25 and NEMA MG1/31.2006.



NSX160●MA150

+



LC1D115●●

+



ATV610D55N4

Applications

Circuit breaker/contactors/drive combinations help to ensure continuity of service in an installation. The type of circuit breaker/contactors coordination selected can help reduce maintenance costs in the event of a motor short-circuit on the drive input by minimizing the time required to make the necessary repairs and the cost of replacement equipment. The suggested combinations provide coordination according to the drive rating.

The drive controls the motor, provides a monitoring function against short-circuits between the drive and the motor, and helps protect the motor cable against overloads. Overload monitoring is provided by the drive's motor thermal monitoring function if this has been enabled. Otherwise, an external monitoring device such as a probe or thermal overload relay should be provided. The circuit breaker helps protect the drive's power cables against short-circuits.

IEC standard motor starters

Motor Power (1)	Drive reference	Circuit breaker Reference (2)	Rating (lth) A	I _{rm} A	Line contactor reference (3) (4)	
kW	HP					
Three-phase supply voltage: 380...460 V 50/60 Hz						
0.75	1	ATV610U07N4●	GV2L08	4	51	LC1D09●●
1.5	2	ATV610U15N4●	GV2L10	6.3	78	LC1D09●●
2.2	3	ATV610U22N4●	GV2L14	10	138	LC1D09●●
3	4	ATV610U30N4●	GV2L16	14	170	LC1D25●●
4	5.4	ATV610U40N4●	GV2L16	14	170	LC1D25●●
5.5	7.4	ATV610U55N4●	GV2L16	14	170	LC1D25●●
7.5	10.1	ATV610U75N4●	GV2L20	18	223	LC1D32●●
11	14.9	ATV610D11N4●	GV2L22	25	327	LC1D32●●
15	20.3	ATV610D15N4●	GV3L32	32	448	LC1D40A●●
18.5	25	ATV610D18N4●	GV3L40	40	560	LC1D50A●●
22	30	ATV610D22N4●	GV3L50	50	700	LC1D50A●●
30	40	ATV610D30N4●	NS80HMA80	80	1000	LC1D80●●
37	50	ATV610D37N4●	NS80HMA80	80	1000	LC1D80●●
45	60	ATV610D45N4●	NSX100●●MA100	100	1300	LC1D115●●
55	75	ATV610D55N4●	NSX160●●MA150	150	1500	LC1D115●●
75	100	ATV610D75N4●	NSX160●●MA150	150	1500	LC1D150●●
90	125	ATV610D90N4●	NSX250●●MA220	220	2420	LC1F185●●
110	149	ATV610C11N4●	NSX250●●MA220	220	2420	LC1F185●●
132	178	ATV610C13N4●	NSX400●MIC1●3M320A	320	3500	LC1F265●●
160	216	ATV610C16N4●	NSX400●MIC1●3M320A	320	4000	LC1F265●●

(1) Standard power ratings for 4-pole motors 400 V 50/60 Hz. The values expressed in HP comply with the NEC (National Electrical Code).

(2) For references to be completed, replace the dot with the letter corresponding to the breaking performance of the circuit breaker (F, N, H, S or L). See table below for breaking capacity of circuit breakers according to standard IEC 60947-2:

Circuit breaker	I _{cu} (kA) for 380...460 V					
	F	N	H	S	L	
GV2L08...L14 (5)	130	–	–	–	–	
GV2L14...L22	50	–	–	–	–	
GV3L32...L65	50	–	–	–	–	
NS80HMA	70	–	–	–	–	
NSX100●●MA100	–	36	50	70	100	
NSX160●●MA150	–	36	50	70	100	
NSX250●●MA220	–	36	50	70	100	
NSX400●●Micrologic 1●3-M	–	36	50	70	100	

(3) Composition of contactors:

LC1D09...D150: 3 poles + 1 NO auxiliary contact and 1 NC auxiliary contact.

LC1F185...LC1F265: 3 poles. To add auxiliary contacts or other accessories, please refer to the "Motor-starter solutions - Control and protection components" catalog.

(4) Replace ●● with the control circuit voltage reference indicated in the table below:

	Volts ~	24	48	110	220	230	240
LC1D09 ...LC1D150	50 Hz	B5	E5	F5	M5	P5	U5
	60 Hz	B6	E6	F6	M6	–	U6
	50/60 Hz	B7	E7	F7	M7	P7	U7
LC1F185	50 Hz (LX1 coil)	B5	E5	F5	M5	P5	U5
	60 Hz (LX1 coil)	–	E6	F6	M6	–	U6
	40...400 Hz (LX9 coil)	–	E7	F7	M7	P7	U7
LC1F265	40...400 Hz (LX1 coil)	B7	E7	F7	M7	P7	U7

For other voltages available between 24 V and 660 V, or a DC control circuit, please contact our Customer Care Center.

(5) GV2L14: I_{cu} of 130 kA in combination with an ATV610U30N4, I_{cu} of 20 kA with an ATV610U40N4

Variable speed drives

Easy Altivar 610

Coordination table between drives and fuses

Coordination table between drives and fuses							
Variable speed drives					Semi-conductor fuses		
Line current		Isc (kA)	Type	Power (kW)	Nominal current (A)	Type	
380 V	460 V						
3.1	2.6	5	ATV610U07N4●	0.75	8	gR	
5.7	4.8	5	ATV610U15N4●	1.5	10	gR	
7.8	6.5	5	ATV610U22N4●	2.2	12	gR	
10.1	8.4	5	ATV610U30N4●	3	20	gR	
8.8	7.9	5	ATV610U40N4●	4	16	gR	
11.6	10.5	22	ATV610U55N4●	5.5	20	gR	
14.7	12.8	22	ATV610U75N4●	7.5	25	gR	
22	19.6	22	ATV610D11N4●	11	40	gR	
29.4	26.0	22	ATV610D15N4●	15	50	gR	
37.2	33.5	22	ATV610D18N4●	18.5	63	gR	
41.9	36.2	22	ATV610D22N4●	22	80	gR	
62.5	55.8	22	ATV610D30N4●	30	100	gR	
76.6	68.3	22	ATV610D37N4●	37	125	gR	
92.9	82.7	22	ATV610D45N4●	45	160	gR	
111.5	99.7	22	ATV610D55N4●	55	160	gR	
147.9	130.2	22	ATV610D75N4●	75	250	gR	
177.8	159.9	50	ATV610D90N4●	90	250	gR	
200	175.7	50	ATV610C11N4●	110	315	aR	
236	203.8	50	ATV610C13N4●	132	350	aR	
283	249.5	50	ATV610C16N4●	160	400	aR	

Variable speed drives

Easy Altivar 610

Practical information for installation



Variable speed drives 380...460 V IP 20

Overall dimensions

Variable speed drives	W x H x D	
	mm	in.
ATV610U07N4	145 x 297 x 203	5.71 x 11.69 x 7.99
ATV610U15N4	145 x 297 x 203	5.71 x 11.69 x 7.99
ATV610U22N4	145 x 297 x 203	5.71 x 11.69 x 7.99
ATV610U30N4	145 x 297 x 203	5.71 x 11.69 x 7.99
ATV610U40N4	145 x 297 x 203	5.71 x 11.69 x 7.99
ATV610U55N4	145 x 297 x 203	5.71 x 11.69 x 7.99
ATV610U75N4	145 x 297 x 203	5.71 x 11.69 x 7.99
ATV610D11N4	171 x 360 x 233	6.73 x 14.17 x 9.17
ATV610D15N4	171 x 360 x 233	6.73 x 14.17 x 9.17
ATV610D18N4	211 x 495 x 232	8.31 x 19.50 x 9.13
ATV610D22N4	211 x 495 x 232	8.31 x 19.50 x 9.13
ATV610D30N4	226 x 613 x 271	8.90 x 24.10 x 10.67
ATV610D37N4	226 x 613 x 271	8.90 x 24.10 x 10.67
ATV610D45N4	226 x 613 x 271	8.90 x 24.10 x 10.67
ATV610D55N4	290 x 762 x 323	11.42 x 30 x 12.72
ATV610D75N4	290 x 762 x 323	11.42 x 30 x 12.72
ATV610D90N4	290 x 762 x 323	11.42 x 30 x 12.72
ATV610C11N4	320 x 853 x 390	12.48 x 33.54 x 15.35
with option VW3A9704	320 x 1159 x 390	12.48 x 45.63 x 15.35
ATV610C13N4	320 x 853 x 390	12.48 x 33.54 x 15.35
with option VW3A9704	320 x 1159 x 390	12.48 x 45.63 x 15.35
ATV610C16N4	320 x 853 x 390	12.48 x 33.54 x 15.35
with option VW3A9704	320 x 1159 x 390	12.48 x 45.63 x 15.35

dv/dt filters

Overall dimensions

dv/dt filters	W x H x D	
	mm	in.
VW3A5301	295 x 535 x 215	11.61 x 21.06 x 8.47
VW3A5302	295 x 535 x 215	11.61 x 21.06 x 8.47
VW3A5303	295 x 535 x 215	11.61 x 21.06 x 8.47
VW3A5304	295 x 560 x 245	11.61 x 22.05 x 9.65
VW3A5305	295 x 610 x 245	11.61 x 24.02 x 9.65
VW3A5306	380 x 235 x 350	14.96 x 9.25 x 13.78
VW3A5307	360 x 420 x 270	14.17 x 16.54 x 10.63



Variable speed drives 380...460 V IP 20

Overall dimensions

Variable speed drives	W x H x D	
	mm	in.
ATV610U07N4Z	130 x 284 x 196	5.12 x 11.18 x 7.72
ATV610U15N4Z	130 x 284 x 196	5.12 x 11.18 x 7.72
ATV610U22N4Z	130 x 284 x 196	5.12 x 11.18 x 7.72
ATV610U30N4Z	130 x 284 x 196	5.12 x 11.18 x 7.72
ATV610U40N4Z	130 x 284 x 196	5.12 x 11.18 x 7.72
ATV610U55N4Z	130 x 284 x 196	5.12 x 11.18 x 7.72
ATV610U75N4Z	130 x 284 x 196	5.12 x 11.18 x 7.72
ATV610D11N4Z	155 x 345 x 225	6.10 x 13.58 x 8.86
ATV610D15N4Z	155 x 345 x 225	6.10 x 13.58 x 8.86
ATV610D18N4Z	195 x 480 x 225	7.68 x 18.90 x 8.86
ATV610D22N4Z	195 x 480 x 225	7.68 x 18.90 x 8.86
ATV610D30N4Z	212 x 600 x 262	8.35 x 23.62 x 10.31
ATV610D37N4Z	212 x 600 x 262	8.35 x 23.62 x 10.31
ATV610D45N4Z	212 x 600 x 262	8.35 x 23.62 x 10.31
ATV610D55N4Z	268 x 748 x 307	10.55 x 29.45 x 12.09
ATV610D75N4Z	268 x 748 x 307	10.55 x 29.45 x 12.09
ATV610D90N4Z	268 x 748 x 307	10.55 x 29.45 x 12.09
ATV610C11N4Z	300 x 850 x 375	11.81 x 33.46 x 14.76
with option VW3A9704	300 x 1156 x 375	11.81 x 45.51 x 14.76
ATV610C13N4Z	300 x 850 x 375	11.81 x 33.46 x 14.76
with option VW3A9704	300 x 1156 x 375	11.81 x 45.51 x 14.76
ATV610C16N4Z	300 x 850 x 375	11.81 x 33.46 x 14.76
with option VW3A9704	300 x 1156 x 375	11.81 x 45.51 x 14.76

dv/dt filters

Overall dimensions

dv/dt filters	W x H x D	
	mm	in.
VW3A5301	295 x 535 x 215	11.61 x 21.06 x 8.47
VW3A5302	295 x 535 x 215	11.61 x 21.06 x 8.47
VW3A5303	295 x 535 x 215	11.61 x 21.06 x 8.47
VW3A5304	295 x 560 x 245	11.61 x 22.05 x 9.65
VW3A5305	295 x 610 x 245	11.61 x 24.02 x 9.65
VW3A5306	380 x 235 x 350	14.96 x 9.25 x 13.78
VW3A5307	360 x 420 x 270	14.17 x 16.54 x 10.63

A		VW3A8306R10	12
ATV610C11N4	6	VW3A8306R30	12
ATV610C11N4Z	7	VW3A8306RC	12
ATV610C13N4	6	VW3A8306TF03	12
ATV610C13N4Z	7	VW3A8306TF10	12
ATV610C16N4	6	VW3A9704	8
ATV610C16N4Z	7	Z	
ATV610D11N4	6	ZB5AZ905	10
ATV610D11N4Z	7		
ATV610D15N4	6		
ATV610D15N4Z	7		
ATV610D18N4	6		
ATV610D18N4Z	7		
ATV610D22N4	6		
ATV610D22N4Z	7		
ATV610D30N4	6		
ATV610D30N4Z	7		
ATV610D37N4	6		
ATV610D37N4Z	7		
ATV610D45N4	6		
ATV610D45N4Z	7		
ATV610D55N4	6		
ATV610D55N4Z	7		
ATV610D75N4	6		
ATV610D75N4Z	7		
ATV610D90N4	6		
ATV610D90N4Z	7		
ATV610U07N4	6		
ATV610U07N4Z	7		
ATV610U15N4	6		
ATV610U15N4Z	7		
ATV610U22N4	6		
ATV610U22N4Z	7		
ATV610U30N4	6		
ATV610U30N4Z	7		
ATV610U40N4	6		
ATV610U40N4Z	7		
ATV610U55N4	6		
ATV610U55N4Z	7		
ATV610U75N4	6		
ATV610U75N4Z	7		
L			
LU9AD7	12		
LU9GC3	12		
V			
VW3A1104R10	10		
VW3A1104R100	10		
VW3A1104R30	10		
VW3A1104R50	10		
VW3A1113	9		
VW3A1114	10		
VW3A3203	11		
VW3A3204	11		
VW3A3607	12		
VW3A5301	13		
VW3A5302	13		
VW3A5303	13		
VW3A5304	13		
VW3A5305	13		
VW3A5306	13		
VW3A5307	13		
VW3A8306R03	12		

Life Is On



Learn more about our products at
www.schneider-electric.com

The information provided in this documentation contains general descriptions and/or technical characteristics of the performance of the products contained herein. This documentation is not intended as a substitute for and is not to be used for determining suitability or reliability of these products for specific user applications. It is the duty of any such user or integrator to perform the appropriate and complete risk analysis, evaluation and testing of the products with respect to the relevant specific application or use thereof. Neither Schneider Electric nor any of its affiliates or subsidiaries shall be responsible or liable for misuse of the information contained herein.

Design: Schneider Electric
Photos: Schneider Electric

Schneider Electric Industries SAS

Head Office
35, rue Joseph Monier - CS 30323
F-92500 Rueil-Malmaison Cedex
France

DIA2ED2140702EN
January 2021 - V8.0